

Panasonic®

SIRIUS Satellite Radio And Traffic Tuner Interface
Radio satellite SIRIUS et Interface de réglage des canaux de trafic
Radio de satélite SIRIUS y cable para el sintonizador de tráfico

Model: **CA-LSR10U**

Operating Instructions Manuel d'instructions Manual de Instrucciones

- Please read these instructions (including “Limited warranty”) carefully before using this product and keep this manual for future reference.
- Prière de lire attentivement ces instructions (y compris la « Garantie limitée ») avant d'utiliser ce produit et conserver ce manuel d'instructions pour s'y référer ultérieurement.
- Lea con atención estas instrucciones antes de utilizar el producto y guarde este manual para poderlo consultar en el futuro.

Safety information

- ❑ Read the operating instructions for the product and all other components of your car navigation system carefully before using the system. They contain instructions about how to use the system in a safe and effective manner. Panasonic assumes no responsibility for any problems resulting from failure to observe the instructions given in this manual.
- ❑ This manual uses pictographs to show you how to use the product safely and to alert you to potential dangers resulting from improper connections and operations. The meanings of the pictographs are explained below. It is important that you fully understand the meanings of the pictographs in order to use this manual and the system properly.



This pictograph alerts you to the presence of important operating instructions. Failure to heed the instructions may result in severe injury or death.

Warning



This pictograph alerts you to the presence of important operating instructions. Failure to heed the instructions may result in injury or material damage.

Caution



Warning

Observe the following warnings when using this product.

- ❑ **The driver should neither watch the display nor operate the system while driving.**
Watching the display or operating the system will distract the driver from looking ahead of the vehicle and can cause accidents. Always stop the vehicle in a safe location and use the parking brake before watching the display or operating the system. In some states and countries, passengers are also prohibited from watching the display.
- ❑ **Follow actual traffic regulations while driving.**
Even while following route guidance, always obey road signs and abide all traffic laws. Failure to do so could cause an accident or injury.
- ❑ **Use the proper power supply.**
This product is designed for operation with a negative grounded 12 V DC battery system. Never operate this product with other battery systems, especially a 24 V DC battery system. If it is used in the wrong type of car, it may cause a fire or an accident.
- ❑ **Park your car in a safe place and pull the side brake (parking brake) lever before watching the monitor. Never operate the iPod® during driving, either. Failure to observe this may result in an accident.**

Observe the following warnings when installing.

- ❑ **Disconnect the lead from the negative (-) battery terminal before installation.**

Wiring and installation with the negative (-) battery terminal connected may cause electrical shock and injury due to a short circuit.

Some cars equipped with the electrical safety system have specific procedures of battery terminal disconnection.

FAILURE TO FOLLOW THE PROCEDURES MAY LEAD TO THE UNINTENDED ACTIVATION OF THE ELECTRICAL SAFETY SYSTEM RESULTING IN DAMAGE TO THE VEHICLE AND PERSONAL INJURY OR DEATH.

- ❑ **Installing the product on the air bag cover or in a location where it interferes with airbag operation is prohibited.**
- ❑ **After installation and wiring, you should check the normal operation of other electrical equipment.**
- ❑ **Never attempt to playback the Program disc with usual DVD/CD player.**

Significant noise may cause disorder to your ears or damage your speaker.

- ❑ **Wiring without any interference from seat sliding or human movements such as driving and getting in or out of a car.**

Perform wiring and clamp the cords so that the steering wheel, gearshift lever, seat belt, brake pedal, your feet and legs, and others are not caught by the cords. Exercise extra care to avoid catching the cords by sliding the seat. Failure to observe this may cause an accident, injury, or fire.

- ❑ **Make sure to turn off the power of the devices before wiring them.**
- ❑ **Instruction-based installation and wiring.**
- ❑ **Do not attempt to disassemble, repair or modify the system.**

Perform installation and wiring in accordance with the instructions. Failure to observe the instructions may cause an accident or fire.

Never attempt to disassemble, repair or modify the system, or to remove cable insulation to take power supply from other devices. Fire, accident or electric shock could result.

Safety information (continued)

Caution

Observe the following cautions when installing.

- ❑ **Refer wiring and installation to qualified service personnel.**

Installation of this product requires special skills and experience. For maximum safety, have it installed by your dealer. Panasonic is not liable for any problems resulting from your own installation of the product.

- ❑ **Take care not to damage the leads.**

When wiring, take care not to damage the leads. Prevent them from getting caught in the vehicle chassis, screws, and moving parts such as seat rails. Do not scratch, pull, bend or twist the leads. Do not run them near heat sources or place heavy objects on them. If leads must be run over sharp metal edges, protect the leads by winding them with vinyl tape or similar protection.

- ❑ **Do not use the product where it is exposed to water, moisture, or dust.**

- ❑ **Use accessories and the designated parts.**

The use of parts other than those supplied or designated may result in internal damage to the product. Faulty installation may lead to an accident, a malfunction or fire.

Limited warranty

U.S.A.

PANASONIC CONSUMER ELECTRONICS COMPANY,
DIVISION OF PANASONIC CORPORATION OF NORTH AMERICA
One Panasonic Way, Secaucus, New Jersey 07094

PANASONIC SALES COMPANY,
DIVISION OF PANASONIC PUERTO RICO, INC.
Ave. 65 de infantería, Km. 9.5, San Gabriel Industrial Park
Carolina, Puerto Rico 00985

PANASONIC AUTO PRODUCTS LIMITED WARRANTY

LIMITED WARRANTY COVERAGE

If your product does not work properly because of defects in materials and workmanship.

Panasonic Consumer Electronics Company or Panasonic Sales Company (collectively referred to as “the warrantor”) will, for the length of the period indicated in the chart below, which starts with the date of original purchase (“warranty period”), at its option either (a) repair your product with new or refurbished parts, or (b) replace it with a new or refurbished product. The decision to repair or replace will be made by the warrantor.

Categories	Parts	Labor
Audio Components (except items listed below)	One (1) Year	One (1) Year
MXE Series Audio Components (except items listed below)	Two (2) Years	Two (2) Years
Speakers Defective Car Audio Speakers under warranty must be exchanged at the place of purchase. Contact your Dealer for details.	One (1) Year	Not Applicable
Accessories (in exchange for defective items)	Ninety (90) Days	Not Applicable

During the “Labor” warranty period, there will be no charge for labor.
During the “Parts” warranty period, there will be no charge for parts. You must carry in or mail in your product prepaid during the warranty period.

If non-rechargeable batteries are included, they are not warranted. This warranty only applies to products purchased and serviced in the United States or Puerto Rico. This warranty is extended only to the original purchaser of a new product which was not sold “as is”. A purchase receipt or other proof of the original purchase date is required for warranty service.

CARRY-IN OR MAIL-IN SERVICE

For Carry-In or Mail-In Service in the United States, call 1-800-211-PANA (7262) or visit

Panasonic Web Site: <http://www.panasonic.com>

For assistance in Puerto Rico, call Panasonic Sales Company (787)-750-4300 or fax (787)-768-2910.

LIMITED WARRANTY LIMITS AND EXCLUSIONS

This warranty **ONLY COVERS** failures due to defects in materials and workmanship, and **DOES NOT COVER** normal wear and tear or cosmetic damage. The warranty **ALSO DOES NOT COVER** damages which occurred during shipment, failures which are caused by products not supplied by the warrantor, failures which result from accident, misuse, abuse, neglect, bug infestation, mishandling, misapplication, alteration, faulty installation, set-up adjustment, maladjustment of consumer control, improper maintenance, improper antenna, inadequate signal reception or pickup, power line surge, improper voltage supply, lightning, modification, commercial use (such as use in hotels, offices, restaurants, or other business uses) or rental use of the product, or service by anyone other than the technician from Factory Servicenter or other authorized service centers, or damage that is attributable to acts of God.

THERE ARE NO EXPRESS WARRANTIES EXCEPT AS LISTED UNDER “LIMITED WARRANTY COVERAGE”. THE WARRANTOR IS NOT LIABLE FOR INCIDENTAL OR CONSEQUENTIAL DAMAGES RESULTING FROM THE USE OF THIS PRODUCT, OR ARISING OUT OF ANY BREACH OF THIS WARRANTY.

(As examples, this excludes damages for lost time, cost of having someone remove or re-install an installed unit if applicable, travel to and from the servicer, and loss of media, data or other memory contents. The items listed are not exclusive, but are

Limited warranty (continued)

for illustration only.) **ALL EXPRESS AND IMPLIED WARRANTIES, INCLUDING THE WARRANTY OF MERCHANTABILITY, ARE LIMITED TO THE PERIOD OF THE LIMITED WARRANTY.**

Some states do not allow the exclusion or limitation of incidental or consequential damages, or limitations on how long an implied warranty lasts, so the exclusions may not apply to you.

This warranty gives you specific legal rights and you may also have other rights which vary from state to state. If a problem with this product develops during or after the warranty period, you may contact your dealer or Servicenter. If the problem is not handled to your satisfaction, then write to warrantor's Consumer Affairs Department at the addresses of the warrantor.

PARTS AND SERVICE WHICH ARE NOT COVERED BY THIS LIMITED WARRANTY ARE YOUR RESPONSIBILITY.

CANADA

Panasonic Canada Inc.

5770 Ambler Drive, Mississauga Ontario L4W 2T3

PANASONIC PRODUCT LIMITED WARRANTY

Panasonic Canada Inc. warrants this product to be free from defects in materials and workmanship and agrees to remedy any such defect for a period as stated below from the date of original purchase.

CAR AUDIO PRODUCT – ONE (1) YEAR, PARTS AND LABOUR

(The labour to install or remove the product is not warranted)

ACCESSORIES - NINETY (90) DAYS, (IN EXCHANGE FOR DEFECTIVE ITEMS)

LIMITATIONS AND EXCLUSIONS

This warranty does not apply to products purchased outside Canada or to any product which has been improperly installed, subjected to usage for which the product was not designed, misused or abused, damaged

during shipping, or which has been altered or repaired in any way that affects the reliability or detracts from the performance, nor does it cover any product which is used commercially. Dry cell batteries are also excluded from coverage under this warranty.

This warranty is extended to the original end user purchaser only. A purchase receipt or other proof of the original purchase date is required before warranty service is performed.

THIS EXPRESS, LIMITED WARRANTY IS IN LIEU OF ALL OTHER WARRANTIES, EXPRESS OR IMPLIED, INCLUDING ANY IMPLIED WARRANTIES OF MERCHANTABILITY AND FITNESS FOR A PARTICULAR PURPOSE.

IN NO EVENT WILL PANASONIC CANADA INC. BE LIABLE FOR ANY SPECIAL, INDIRECT OR CONSEQUENTIAL DAMAGES.

In certain instances, some jurisdictions do not allow the exclusion or limitation of incidental or consequential damages, or the exclusion of implied warranties, so the above limitations and exclusions may not be applicable.

WARRANTY SERVICE

FOR PRODUCT OPERATION ASSISTANCE, please contact:

Our Customer Care Centre:

Telephone #: (905) 624-5505

1-800 #: 1-800-561-5505

Fax #: (905) 238-2360

Email link: "Contact Us" on www.panasonic.ca

FOR PRODUCT REPAIRS, please locate your nearest Authorized Servicentre at www.panasonic.ca:



Link : "Servicentres™ locator" under "Customer support"

IF YOU SHIP THE PRODUCT TO A SERVICENTRE

Carefully pack and send prepaid, adequately insured and preferably in the original carton.

Include details of the defect claimed, and proof of date of original purchase.

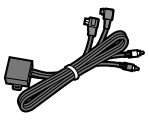
Components

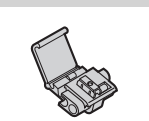
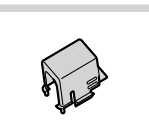
	① SIRIUS tuner cable (YEAETLSR10U)	Qty: 1
	② Power connector (YEAEPLSR10U)	Qty: 1
	③ Velcro tape (YFX994C164CA)	Qty: 1
	④ Clip connector (YEFX9991154)	Qty: 2
	⑤ Connector cover (YEFX9993136)	Qty: 1

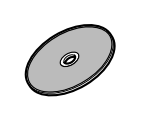
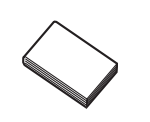
	Program disc (YFX994C165ZA)	Qty: 1
	Operating Instructions (YFM264C082CA)	Qty: 1

Note:

- The number in parentheses underneath each accessory part name is the part number for maintenance and service.
- Accessories and their parts numbers are subject to modification without prior notice due to improvements.
- Some figures and illustrations in this manual may be different from your product.

Introduction

- This manual contains explanations for those who have never before upgraded the software version. After downloading the upgraded program version from our download site, some of the new functions described in this manual may already be installed.
- Read the operating instructions of each of the devices to be connected carefully to ensure correct and safe use.

■ Features

● **SIRIUS Satellite Radio Plus Traffic Tuner (SIR-SC10T) compatible**

By connecting to a SIRIUS Satellite Radio Plus Traffic Tuner (SIR-SC10T), you can receive traffic information and display the information on the map screen. Also, you can take the received traffic information into account when searching for routes.

● **SIRIUS Connect Vehicle Tuner (SC-C1) compatible**

You can connect a SIRIUS Connect Vehicle Tuner (SC-C1).

● **iPod with video connectivity**

By connecting an iPod with video using a direct cable for iPod with video (CA-VDC300U, option), you can watch videos stored on the iPod with video.

● **3D map display**

You can switch the map display to 3D display.

● **Expansion module AV input compatible**

By using an Expansion module (CY-EM100U, option), you can simultaneously connect devices such as a TV tuner (CY-TUN153U, option) and iPod with video, or other such devices.

Precautions for using this product

- Only functions that are newly added or changed by upgrading the software version are explained. For details of the other functions, read the Operating Instructions that were included with the navigation unit together with the System Upgrade Guidebook.
- If you are using a device that uses AV-IN, such as the TV tuner (CY-TUN153U, option), and want to connect a SIRIUS Satellite Radio Tuner (SIR-SC10T)/SIRIUS Connect Vehicle Tuner (SC-C1) or iPod with video simultaneously, you also need the Expansion module (CY-EM100U, option).
 - * SIRIUS Satellite Radio Plus Traffic Tuner (SIR-SC10T) and SIRIUS Connect Vehicle Tuner (SC-C1) cannot be connected simultaneously to the navigation system.

Note:

- No part of this disc may be reproduced or duplicated without prior consent.

Using the Disc

- If the disc is dirty or scratched, or if the pickup lens is dirty, the disc may become unreadable, and you will not be able to update the software. If this problem occurs, consult your dealer.
- When inserting and removing the disc from the case, do not scratch or leave fingerprints on the surface of the disc.
- Do not stick paper on the disc label, or scratch the disc surface.
- To avoid the disc becoming dirty, scratched, or warped when not in use for long periods of time, always store it in the storage case.
- Do not store the disc in a place that is exposed to long periods of direct sunlight, damp or dusty places, or on the seats or dashboard of your vehicle.
- Do not bend the disc.

Contents

English

Français

Español

Safety information	2
Limited warranty	5
Components	7
Introduction	8
Contents	9
Preparation	10
SIRIUS Traffic	12
3D screen	22
Operation of the right screen	23
Change navigation settings	24
iPod with video control	26
Mounting	30
Wiring	30
Troubleshooting	36

Preparation

Upgrading the Navigation Software

Once the version is updated, it cannot be restored to the former version.

- 1 **Start the engine.**
(Or turn the key to ACC.)
- 2 **Select [I agree] on the WARNING screen.**
- 3 **Press .**
 - The Open/Tilt/Eject screen is displayed.
- 4 **Select [Disc].**
 - The monitor opens.
 - If there is a disc inside, it is ejected automatically.
- 5 **Insert the program disc.**

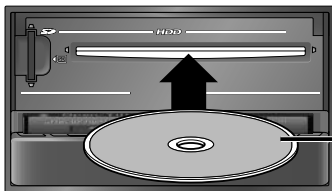

- The monitor closes automatically.

6 Select [Yes/Oui/SÍ].



- The program starts to load.

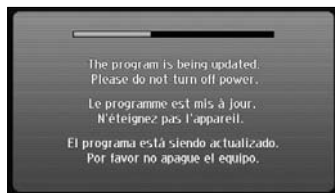

- Do not turn off the engine while the program is loading. (Do not switch ACC OFF.)
If program loading is interrupted, it will start again from the beginning the next time the engine is turned on (or the next time ACC is turned ON).

7 When the program has finished loading,
Select [Disc/Disque/Disco].

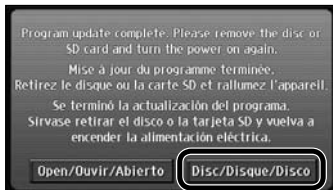

- The monitor opens and the disc is ejected.

8 **Remove the disc.**

9 **Select [Close/Fermer/Cerrar].**

- The monitor closes.

10 **Turn off the engine and turn on the engine again or switch ACC on.**

- The newly added functions are now ready for use.

Note:

- If the version of the navigation unit is already updated, a message is displayed to notify you that an update will not be performed. Eject the disc and turn the power off and on prior to use.

SIRIUS Traffic

What is SIRIUS Traffic?

SIRIUS Traffic provides traffic data to vehicles over our nationwide satellite radio network. This includes updated traffic information on accidents, scheduled road closings, traffic flow and other traffic-related incidents. Since the service is integrated with a vehicle's navigation system, SIRIUS Traffic can help drivers pick the fastest route based on real-time traffic conditions.

For information on the areas in which you can use the Flow and Event functions of SIRIUS Traffic, and the applicable roads, confirm the latest status on the SIRIUS web page.

Route search using traffic information

Search for a route that avoids traffic information (such as traffic jam).

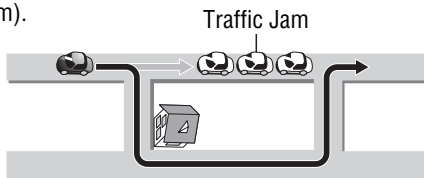

Note:

- A route search using traffic information considers the following information, except for forecast information.
 - Closed road (Except for entry closed and exit closed)
 - Traffic
 - Traffic Flow/Heavy

Preparation:

- Connect the optional SIRIUS Satellite Radio Plus Traffic Tuner (SIR-SC10T). (⇒ page 31)

Displaying the SIRIUS TRAFFIC menu

[Sirius Traffic] is displayed on the Setup menu by connecting the SIRIUS Satellite Radio Plus Traffic Tuner.

1 Select [Setup] from the Navigation menu.



- The Setup menu is displayed.

2 Select [SIRIUS Traffic].



- The SIRIUS TRAFFIC menu is displayed.

■ SIRIUS TRAFFIC menu

System status

- Displays the connection status of the SIRIUS Satellite Radio Plus Traffic Tuner.



Signal meter

- Displays the SIRIUS Satellite Radio Plus receive status (4 levels: from 0 to 3).

Note:

- When you are unable to use the SIRIUS Traffic, confirm the system status.

Message	Possible cause	Possible solution
NO SIRIUS	Cannot receive SIRIUS Satellite Radio.	Verify the wiring.
ANTENNA ERROR	SIRIUS antenna unconnected.	Connect the SIRIUS antenna.
UPDATING	The data is being updated.	Wait a while. You can use SIRIUS Traffic after updating ends.
ACTIVATION REQUIRED	You have not obtained a contract for SIRIUS Traffic.	Obtain a contract for SIRIUS Traffic.

- [Traffic On Route] is displayed during route guidance.
- [Urgent Information] is displayed when urgent information is received.

Getting started

You need to register to be able to use the SIRIUS Satellite Radio Plus Traffic Tuner. Call after confirming your SIRIUS ID (for traffic).

- Phone number: 1-800-869-5364

Note:

- The SIRIUS ID (for traffic) displayed on the SIRIUS Traffic differs from SIRIUS ID (⇒ System Upgrade Guidebook) displayed on the SIRIUS Satellite Radio. When contracting, use each of the IDs to obtain a contract for SIRIUS Traffic and SIRIUS Satellite Radio respectively.

SIRIUS Traffic (continued)

Traffic information on the map



Traffic indicator

- The color of the characters changes according to the receive status.
 - Black Character: Received
 - Grey Character: Not received
- The background color of the traffic indicator changes according to the traffic information.
 - White: There is traffic information.
 - Grey: There is no traffic information.
 - Yellow: There is traffic information within approximately 30 miles (50 km) along the route in the heading direction.
 - Pale Blue: There is other traffic information within approximately 30 miles (50 km) along the route in the heading direction.

Traffic information

Within the extent of influence of each of the traffic information items, an icon is displayed at the closest point from the vehicle position, and an extent line is displayed from the icon to the end point of traffic information.

Note:

























- Up to 300 traffic information items closest to your vehicle are displayed.
- It can be set to display/not display. (⇒ page 20)

Flow

Icon	Extent line	Average speed*	Traffic indicator color
 (Red number)	 (Red)	mph: 5 mph, 10 mph km/h: 10 km/h, 20 km/h	Yellow
 (Black number)	 (Orange)	mph: 20 mph, 25 mph, 30 mph, 40 mph, 45 mph km/h: 30 km/h, 40 km/h, 50 km/h, 60 km/h, 70 km/h	
 (Green)	 (Green)	Traffic flowing freely	

* Mph and km/h switches according to the distance setting (⇒ Operating Instructions).

■ Event

Icon	Extent line	Event content	Traffic indicator color
	 (Yellow)	Closed Road	Yellow
	 (Yellow)	Entry Closed	Yellow
	 (Yellow)	Exit Closed	Yellow
	 (Yellow)	Traffic (Heavy Traffic, etc.)	Yellow
	 (Yellow)	Accidents	Yellow
	 (Yellow)	Danger (Broken down vehicle, etc.)	Yellow
	 (Pale Blue)	Road Conditions (Lane closed, etc.)	Pale Blue
	 (Pale Blue)	Delays (Long delays, etc.)	Pale Blue
	 (Yellow)	Road works	Yellow
	 (Pale Blue)	Weather (Heavy rain, etc.)	Pale Blue
	 (Pale Blue)	Parking (Parking information, etc.)	
	 (Pale Blue)	Others (Major event, etc.)	

Note:

- The color of the icons changes depending on the type of information.
 - Red: Present information
 - Red & Red frame: Emergency information
 - Pale Blue: Forecast information

SIRIUS Traffic (continued)

Traffic information display

You can check the traffic information displayed on the map.

Note:

- The unit of the average speed of the flow displayed in the traffic event type varies depending on the languages. It does not follow the distance setting. (⇒ Operating Instructions)
 - English: mph
 - French: km/h
 - Spanish: km/h

Display from the map screen

1 Put the cursor on the traffic icon.

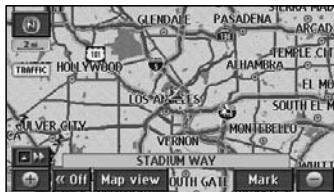

- The traffic event type is displayed on the top of the screen.

2 Select [Info.].

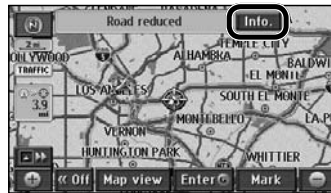

- The traffic information screen is displayed.

Road number or street name

Traffic event type

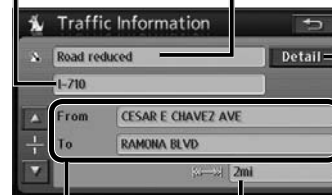

Display detailed traffic information*

The name of the location where the event occurred.

If there is distance information within the affected area, the icon and distance are displayed.

* This is not displayed in the Flow screen.

■ Traffic on route

Displays traffic information content on route.

Select [Traffic On Route] from the SIRIUS TRAFFIC menu.

- The Traffic On Route screen is displayed.

Road number or street name

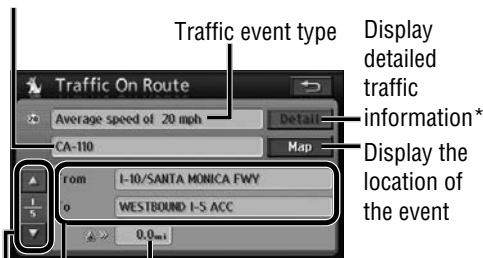

The distance from your vehicle to the traffic information.

The name of the location where the event occurred.

When there are multiple traffic information items, you can use , to view other items.

* This is not displayed in the Flow screen.

■ Urgent information

When urgent information is received, you are informed that urgent information was received on the screen.

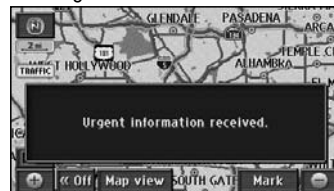

Select [Urgent Information] from the SIRIUS TRAFFIC menu.

- The Urgent Information screen is displayed.

Road number or street name



The name of the location where the event occurred.

* This is not displayed in the Flow screen.

SIRIUS Traffic (continued)

Traffic information display (continued)

■ All traffic events

Display all received traffic information content for each road.

- A list of roads that have no road numbers (roads with street names only or area information) is displayed when [Other info] is selected.

1 Select [All Traffic Events] from the SIRIUS TRAFFIC menu.

2

Select a road number.



- The All Traffic Events screen is displayed.

Road number or street name



Display detailed traffic information*

Display the location of the event

The name of the location where the event occurred.

* This is not displayed in the Flow screen.

Auto avoid traffic

When traffic information (such as traffic jam) is received during route guidance, a route that avoids the traffic information is searched, and if there is an alternate route, you are informed on the screen.

Select [Auto Avoid Traffic] from the SIRIUS TRAFFIC menu.



Illuminates when On.

- If there is an alternate route, you are informed on the screen.
- Select [Auto Avoid Traffic] again to cancel auto avoid traffic.

■ If there is an alternate route

Confirm the information on the screen, then Select [Yes].

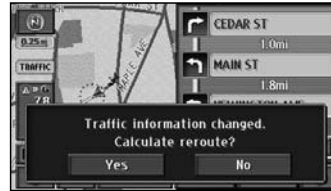

- The route is updated to the alternate route.
- In the following cases, the route is not updated to the alternate route.
 - [No] is selected.
 - Route deviance.
 - The distance to the turning point of the old and alternate route becomes less than 1 mile (1.5 km).

SIRIUS Traffic (continued)

Voice guidance

The voice guidance can be provided for the traffic information on the route during route guidance.

Select [Voice Guidance] from the SIRIUS TRAFFIC menu.

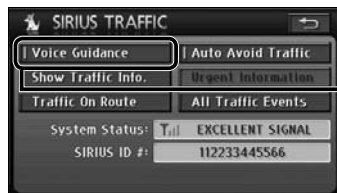

Illuminates when On.

- Select [Voice Guidance] again to cancel voice guidance.

Show traffic information

You can choose the traffic icons displayed on the map.

- 1 **Select [Show Traffic Info.] from the SIRIUS TRAFFIC menu.**
 - The Show Traffic Info. screen is displayed.
- 2 **Select icons to display, then select [OK].**



- The selected icons are canceled when the same icons are selected again.
 - [All On]: Display all icons.
 - [All Off]: Hide all icons.

Note:

- Icons set to be hidden are not used for the following functions.
 - Traffic information on the map (icon & indicator)
 - Display traffic information
 - Voice guidance using traffic information
 - Route search using traffic information (Closed road is always used regardless of the setting.)
- Urgent information is used when received regardless of the setting.

Category list

- The following table shows the icon displayed for each category and the traffic information available for each function.
 ✓ : Available for function – : Not available for function
- Forecast information cannot be used with Traffic on route, Voice guidance, and Route search functions.

Category		Icon displayed on map	All traffic event	Traffic on route	Voice guidance	Route search	
Name	Icon						
Traffic			✓	✓	✓	✓	
Accidents			✓	✓	✓	–	
Closed Road		(Closed Road)	✓	✓	✓	✓	
		(Entry Closed)	✓	✓	✓	–	
		(Exit Closed)	✓	✓	✓	–	
Road Works			✓	✓	✓	–	
Danger			✓	✓	✓	–	
Road Conditions			✓	✓	✓	–	
Weather			✓	✓	✓	–	
Delays			✓	✓	✓	–	
Parking			✓	–	–	–	
Others			✓	–	–	–	
Traffic Flow/Heavy	(Yellow)		mph	✓	✓	✓	✓
				✓	✓	–	✓
			km/h	✓	✓	✓	✓
				✓	✓	–	✓
Traffic Flow/Free	(White)		✓	✓	–	–	

3D screen

You are now able to switch the map display to a 3D display.

Note:

- The angle of inclination of the 3D screen can be adjusted. (⇒ page 25)
- You cannot switch to North up during 3D display.

Adjust the inclination

1 Select [Map view] on the map screen.



- The Change map view screen is displayed.

2 Select [3D].



- The display switches to the 3D screen.

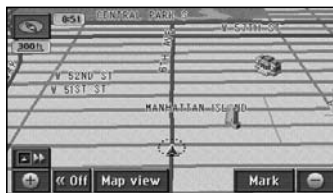

■ To return to the 2D screen

Select [2D] on the Change map view screen.



- The display switches to the 2D screen.

Rotate the map

- 1 Touch the screen while in 3D screen display.

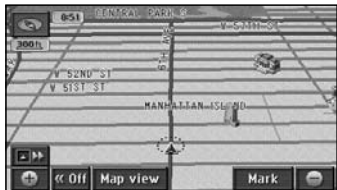

- [Map Rotate Clockwise] [Map Rotate Counterclockwise] are displayed.

- 2 Select the arrows [Map Rotate Clockwise] [Map Rotate Counterclockwise].



- [Map Rotate Clockwise]: The map rotates clockwise.
- [Map Rotate Counterclockwise]: The map rotates counterclockwise.
- Press [MAP] to return to the screen displayed before rotation.

Note:

- For safety reasons, this cannot be operated while driving.

Operation of the right screen

Operations for the right screen during two-screen display (⇒ Operating Instructions) have increased.

Right screen operation

[3D Display]

The display toggles between 3D and 2D each time the button is touched.

Illuminates when On.



[Traffic Info.]*

Touch to toggle traffic icon display on or off for the right screen.

- The icons that are selected on the SIRIUS Traffic Info. screen are displayed.

* This is displayed when a SIRIUS Satellite Radio Plus Traffic Tuner (SIR-SC10T) is connected.

Change navigation settings

Items have been added to Basic navigation settings.

- are items added after upgrading the software version.

Items
Distance
Estimated travel time
Keyboard layout
Time zone
Display POI icons
3D landmark
Display clock
Voice guidance in SRC mode
Auto voice guidance
Delete previous point
Current position
Operation sound
Audio output at "Screen Off"
3D enlarged intersection map
3D route direction upward display
3D map display setting
Map color "Day"
Map color "Night"
Menu picture
Format SD card

Basic navigation settings

- 1 Select [Navigation Setup] from the Setup menu.





- 2 Make settings. (⇒ page 25)



- Use [▲] or [▼] to display the next page.

Note:

- Select [Default] to go to the screen for selecting default setting.
Select [Yes] to return settings to the defaults.

Items	Settings	
<p>[3D enlarged intersection map] Sets whether to display or hide 3D enlarged intersection maps. default: [Off]</p>	<ul style="list-style-type: none"> ● [On]..... Displays 3D enlarged intersection maps. ● [Off] Does not display 3D enlarged intersection maps. 	
<p>[3D route direction upward display] When driving along the guidance route using 3D display, the map orientation is changed to route up orientation (the map is oriented so that the direction of the route is towards the top of the screen). default: [Off]</p>	<ul style="list-style-type: none"> ● [On]..... Sets 3D display to route up orientation. ● [Off] Does not set 3D display to route up orientation. 	
<p>[3D map display setting] Changes the viewpoint angle for 3D display. (⇒ page 22) default: 4</p>	<p>Select [Change].</p>	<p>Adjust the viewpoint angle.</p>  <p>: The inclination increases.</p> <p>: The inclination decreases.</p> <ul style="list-style-type: none"> ● Adjustment range: 1 (increases) – 4 – 10 (decreases) ● Select [Default] to return settings to the defaults.

iPod with video control

Preparation:

- Connect an iPod with video with the Direct cable for iPod with video (CA-VDC300U, option).

Video from the iPod with video is not displayed while the vehicle is in motion.

Stop in a safe place and engage the parking brake before watching video.

Controllable iPod with video/ software version

Connecting a video-output-ready iPod (5th generation, version 1.2) to navigation unit via the Direct Cable for iPod with video (CA-VDC300U, option) allows users to enjoy playing moving pictures or sounds downloaded to the iPod with use of iTunes.

This section describes only video output and its related topics about the 5th generation iPod with video output function (version 1.2). Refer to the System Upgrade Guidebook for other operations at an iPod connected.

* Operation has been confirmed for software available at the end of June, 2007. We do not guarantee proper operation with our future products or upgraded software.

Note:

- **Perform the video playback operation on the iPod with video device.**
- Moving pictures downloaded with iTunes are exclusively playable on navigation unit. Moving pictures using Mass Storage Class are not supported.
- It may take time for the navigation unit to change the source to the iPod after iPod connection.
- On the one hand, if the iPod is connected during audio file playback, the navigation unit plays from the ongoing portion. On the other hand, during video track playback, the navigation unit plays from the beginning of all the files.
- The number of displayable characters for a file name is limited. (up to 252 bytes)
- Switching from the audio display to the video display and the audio display again provides playback from the beginning of the current file.
- By upgrading the software version, iPod and iPod with video volumes are stored separately.

About audio display and video display

[Video] is displayed on the iPod operation screen when the iPod with video is connected.

■ Audio display (iPod operation screen)



Select [Audio].



Select [Video].



■ Video display



Select [Picture].



Press SRC.



Note:

- While the video display is displayed, perform playback operations from the iPod with video device.
- You can play an audio file from the iPod with video device while the video display is displayed, but video is not displayed on the navigation unit.

iPod with video control (continued)

Switch to video display

1 Select [iPod] on the Audiovisual source operation screen.

(⇒ Operating Instructions)



- The iPod operation screen is displayed.

2 Select [Video].



- Displays the iPod with video playback screen.

■ Operation guide message

The Operation guide message is displayed when switching to video display. It presents a simple explanation of iPod with video operation.

Check the explanation, then select [OK].

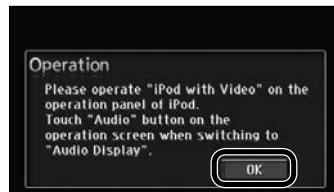

- The Operation guide message disappears.

Note:

- Once [OK] is selected, the Operation guide message will not be displayed again until the engine stops. It appears again after the engine is restarted or the key is turned to ACC ON.

Video operation screen

While displaying the playback screen of the iPod with video,

Press **SRC**.



Displays the iPod with video playback screen.



Returns to the iPod operation screen (audio display).

Note:

- Refer to the Operating Instructions for operation of [Sound] and [ASPECT].

Video menu

Touch the screen while video is displayed to display the video menu.



- Refer to the Operating Instructions for [Display] operations.
- Select [Hide Buttons] to close the video menu.

Mounting

Preparation:

- Wipe all dirt (oil, dust, etc.) off the mounting surface, and dry any moisture.

■ Mounting the I/F Box on the carpet, etc.

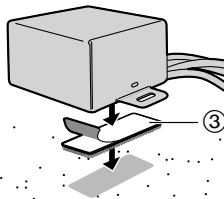

③ Velcro tape

Note:

Do not mount the I/F Box in the following locations. Doing so may cause a malfunction.

- Where exposed to water
- Where the unit may be stepped on
- Very dusty place
- Near a heater duct or object that generates heat
- Where exposed to direct sunlight
- Where heat builds up such as beneath the carpet

Wiring

When disconnecting a locked cable, press the lock in the arrowed direction while removing the connector.

- Pulling too strongly will break the connector. Check that the lock is disengaged before trying to disconnect the connector.

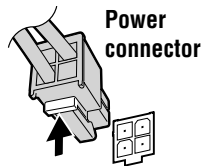

How to attach a clip connector

- 1 Insert the cable into the clip connector.

Vehicle-side wiring cable

Battery lead of this product
(Example)

- 2 Press the element into place.

- 3 Close the cover.

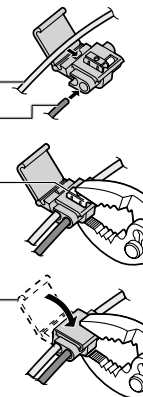

SIRIUS Satellite Radio Plus Traffic Tuner (SIR-SC10T)

- If a device that uses AV-IN, such as a TV tuner (CY-TUN153U, option), is connected to the navigation unit, you cannot connect a SIRIUS Satellite Radio Plus Traffic Tuner (SIR-SC10T). You need to use an Expansion module (CY-EM100U, option) to connect both simultaneously. (⇒ page 34)
- Do not connect anything to the power connector for SIR-SC10T.

- Set the SYSTEM switch to [1]. Do not use [2] and [3].

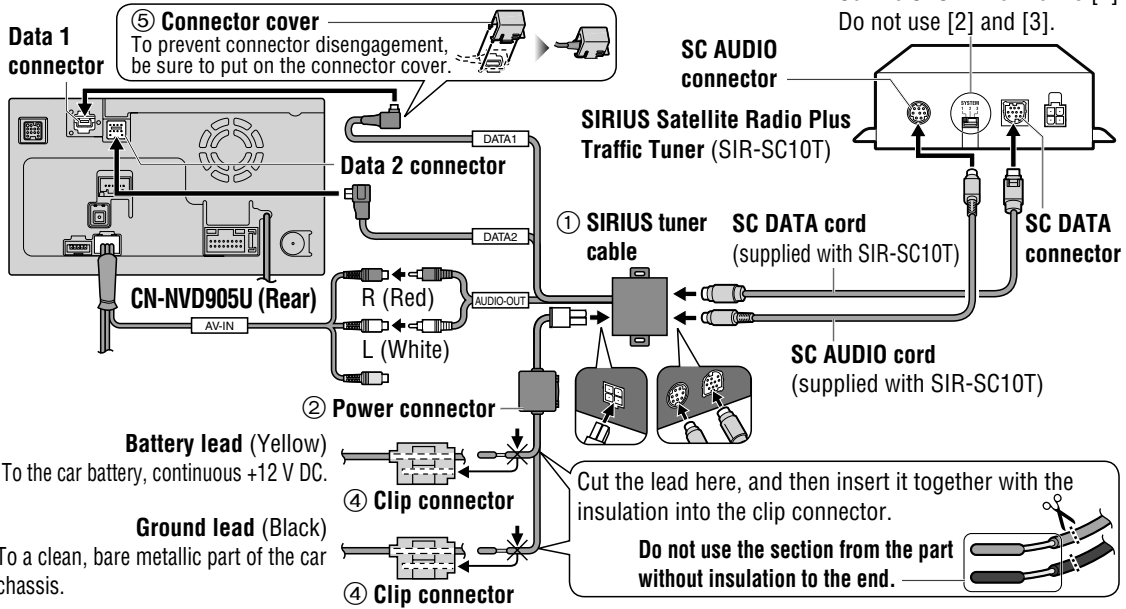

Wiring (continued)

SIRIUS Connect Vehicle Tuner (SC-C1)

- If a device that uses AV-IN, such as a TV tuner (CY-TUN153U, option), is connected to the navigation unit, you cannot connect a SIRIUS Connect Vehicle Tuner (SC-C1).
You need to use an Expansion module (CY-EM100U, option) to connect both simultaneously. (⇒ page 34)

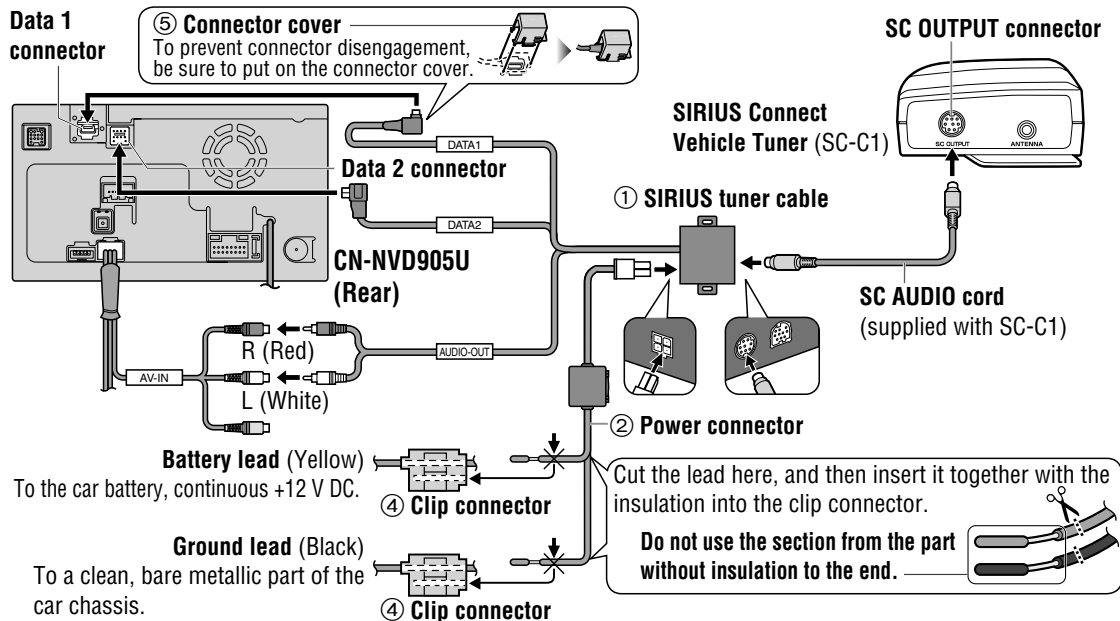

iPod with video

- If a device that uses AV-IN, such as a TV tuner (CY-TUN153U, option), is connected to the navigation unit, you cannot connect an iPod with video.
You need to use an Expansion module (CY-EM100U, option) to connect both simultaneously. (⇒ page 34)

System-up connector

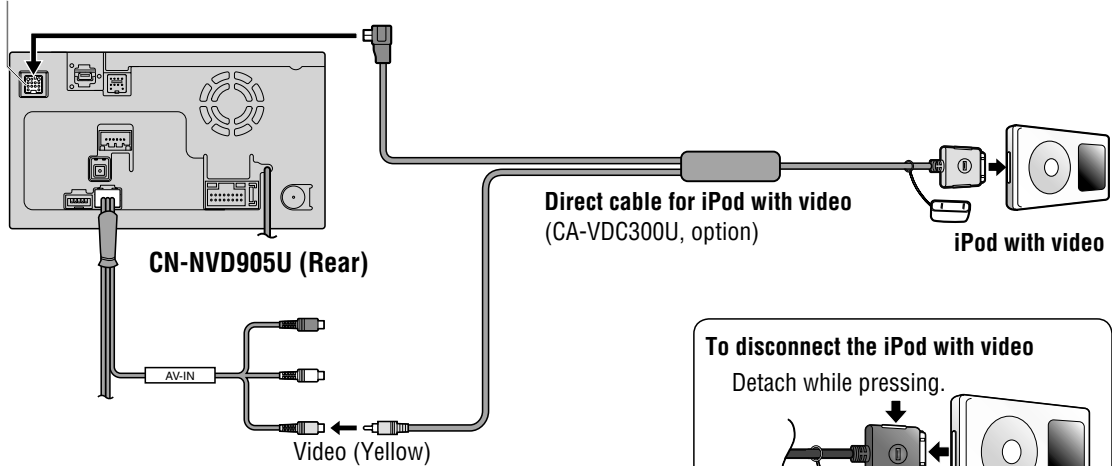

Wiring (continued)

Connection with expansion module (CY-EM100U)

If you use an Expansion module (CY-EM100U, option), you will also be able to connect an iPod with video, TV tuner, SIRIUS Satellite Radio Plus Traffic Tuner/SIRIUS Connect Vehicle Tuner.

- If multiple devices of the same type are connected at the same time, the navigation unit will only recognize one of them.

(For example, if iPod and iPod with video are connected, only one will be recognized.)

To use an Expansion module (CY-EM100U, option) after upgrading the software version, perform the following connections to enable use of the Expansion module (CY-EM100U, option) Video input.

- Always connect the TV Tuner (CY-TUN153U, option), iPod with video or other devices that use the Video input to the Expansion module (CY-EM100U, option).

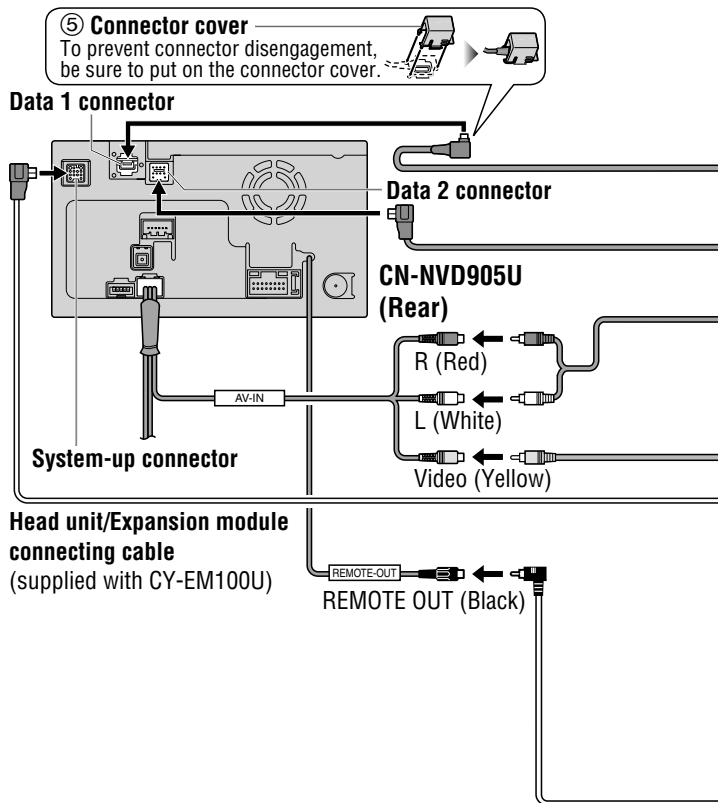

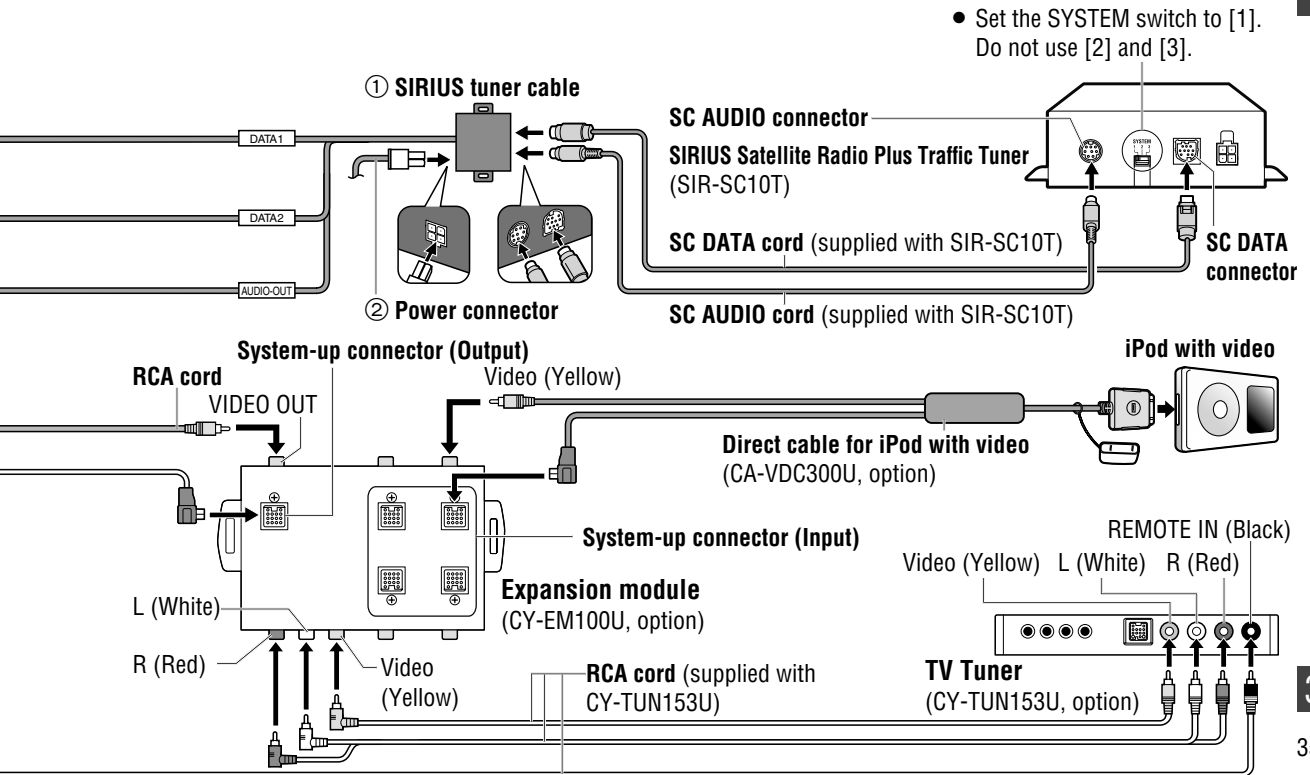

- Set the SYSTEM switch to [1]. Do not use [2] and [3].

Troubleshooting

iPod with video

Problem	Possible cause → Possible solution
<p>The iPod with video pauses.</p>	<p>If you play a video file and then switch to video display when the ACC is switched OFF or the source is other than video display for the navigation unit, the iPod with video comes to a pause. ⇒ Start playback again from the iPod with video.</p>
<p>The navigation unit does not switch to the audio display, even if an iPod with no video function is connected instead of one with a video function.</p>	<p>The navigation unit does not automatically switch from the video display to the audio display. ⇒ Select [Audio] from the video operation screen.</p>
<p>The navigation unit does not switch to the audio display, even when the iPod with video is switched from a video file to an audio file.</p>	
<p>Cannot select [Video].</p>	<p>An iPod with video is not connected. ⇒ Connect an iPod with video.</p>

-
- iPod is a trademark of Apple Inc., registered in the U.S. and other countries.
 - Other names of systems and products mentioned in these instructions are usually the registered trademarks or trademarks of the manufacturers who developed the system or product concerned.
The ™ and ® marks are not used to identify registered trademarks and trademarks in these instructions.

**Panasonic Consumer
Electronics Company,
Division of Panasonic
Corporation of North America**
One Panasonic Way, Secaucus,
New Jersey 07094
<http://www.panasonic.com>

Panasonic Puerto Rico, Inc.
Ave. 65 de Infanteria, Km. 9.5
San Gabriel Industrial Park,
Carolina, Puerto Rico 00985
<http://www.panasonic.com>

Panasonic Canada Inc.
5770 Ambler Drive,
Mississauga, Ontario
L4W 2T3
<http://www.panasonic.ca>

© 2007 Matsushita Electric Industrial Co., Ltd. All Rights Reserved.

YFM264C082CA F0807-0

Printed in China
Imprimé en Chine
Impreso en China